

1 2 3 4 5 6 7 8

A

B

C

D

E

F

A

B

C

D

E

F

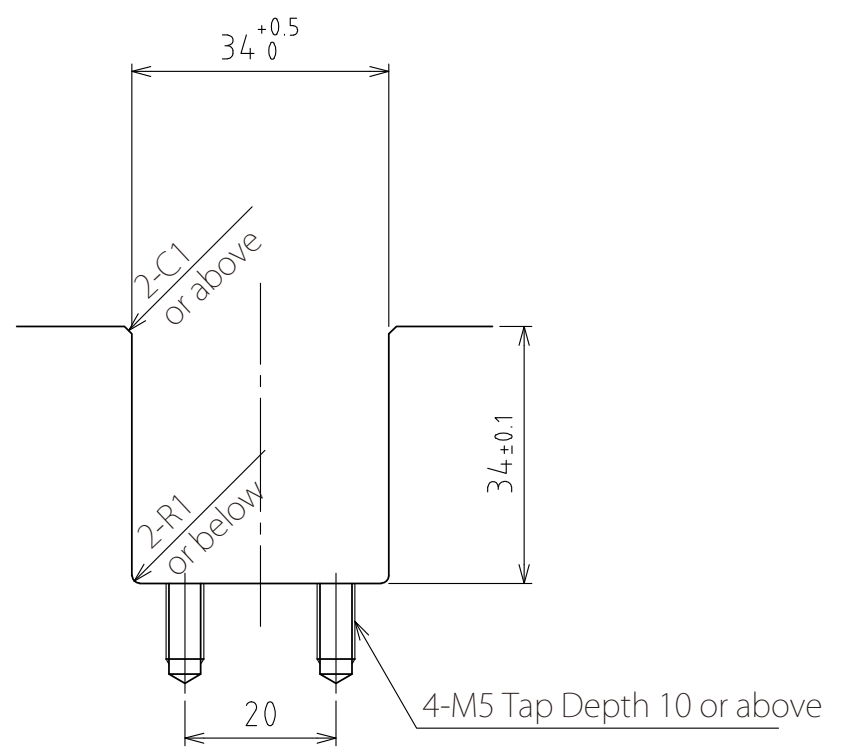
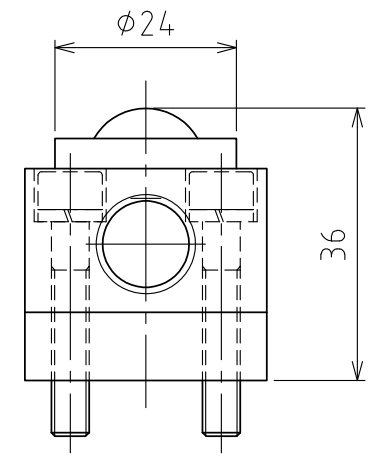
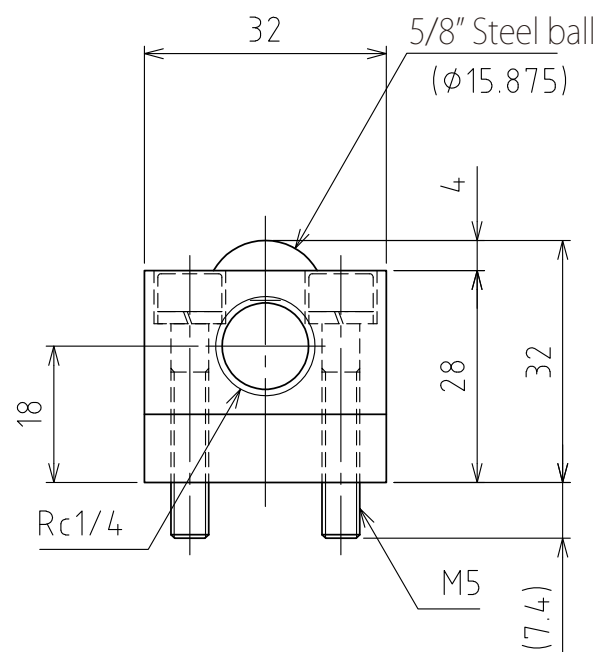
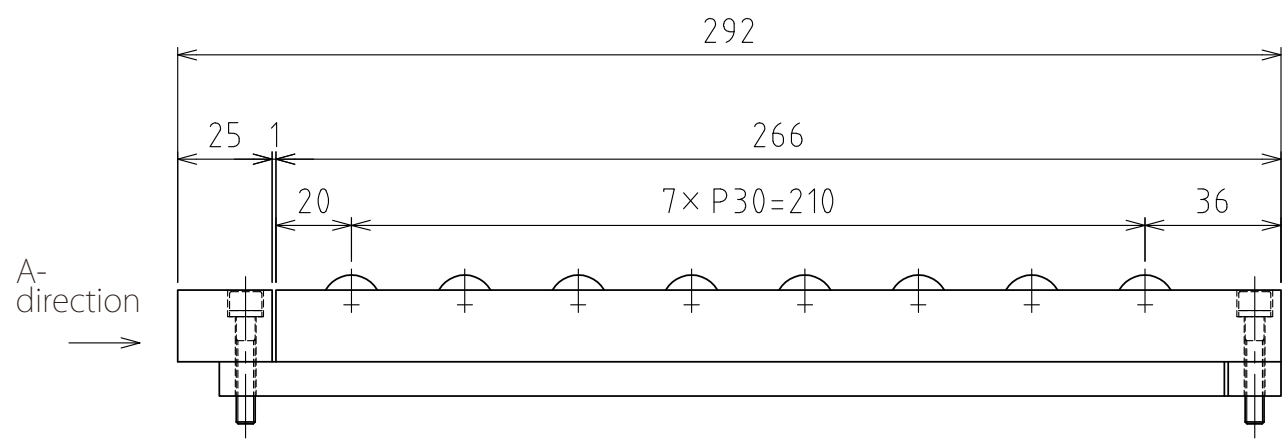
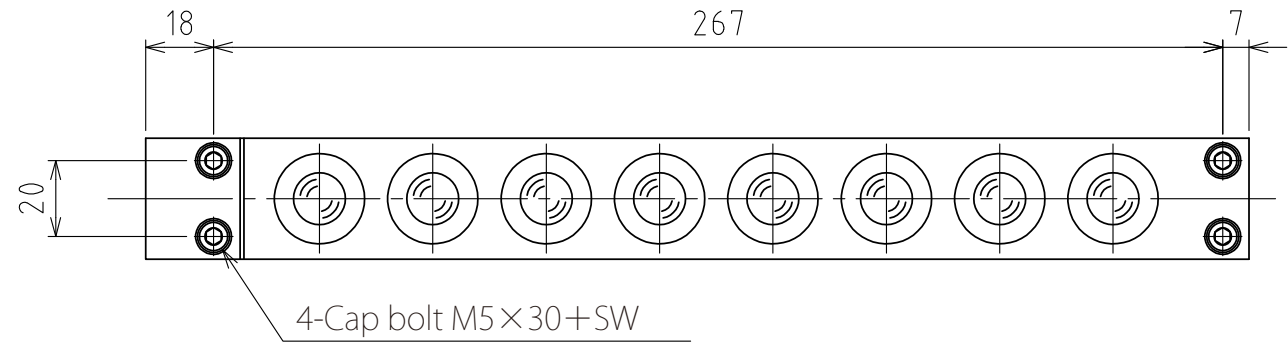

View A

Rising
(stroke 4mm)

Recommended groove dimensions

(Scale 1:1)

spec

Series	AFU-3232series	
Freebear	8pcs	
Material	Ball	SUJ2
	Ball seat	SCM415
	Body	Steel
Weight	1.8kg	

Capacity	Air pressure [MPa(kgf/cm ²)]	Load capacity (Unit) [kN(kgf)]	Load capacity (One freebear) [kN(kgf)]
	0.3 (3.1)	0.96(97.6)	0.12(12.2)
	0.4 (4.1)	1.28(130.4)	0.16(16.3)
	0.5 (5.1)	1.60(163.2)	0.20(20.4)
	0.6 (6.1)	1.92(196.0)	0.24(24.5)

設計 DESIGNED BY	古内	2021/07/27	名称 TITLE	Pneumatically Actuated freebear unit
製図 DRAWN BY	古内	2021/07/27		
検図 CHECKED BY	坂根	21.11.14	承認 APPROVED BY	花村
尺度 SCALE	1:2	サイズ SIZE	A3	AFU-3232-4P-8
第三角法				図面番号 DRAWING NO.
				変更回数 REV.MARK
				SD-01269-F01

1 2 3 4 5 6 7 8