

C-10HALV2

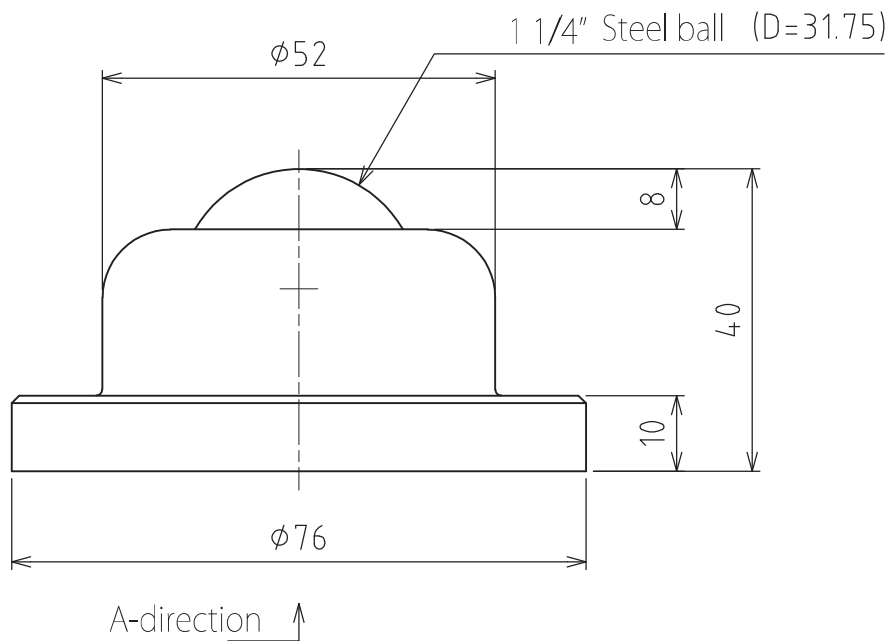
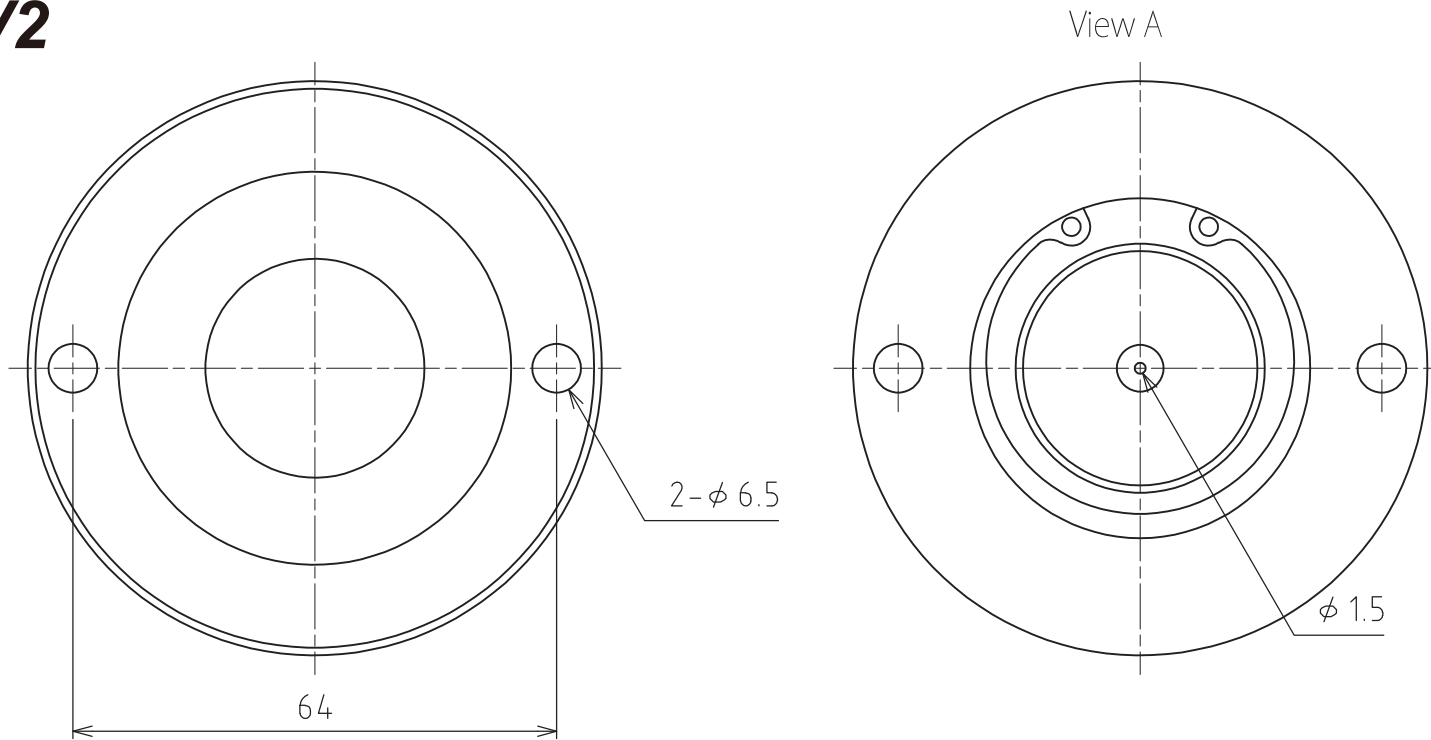

Allowable load : 1568N(160kgf)
Max. load : 3136N(320kgf)
Weight : 414g