

C-12HALV2

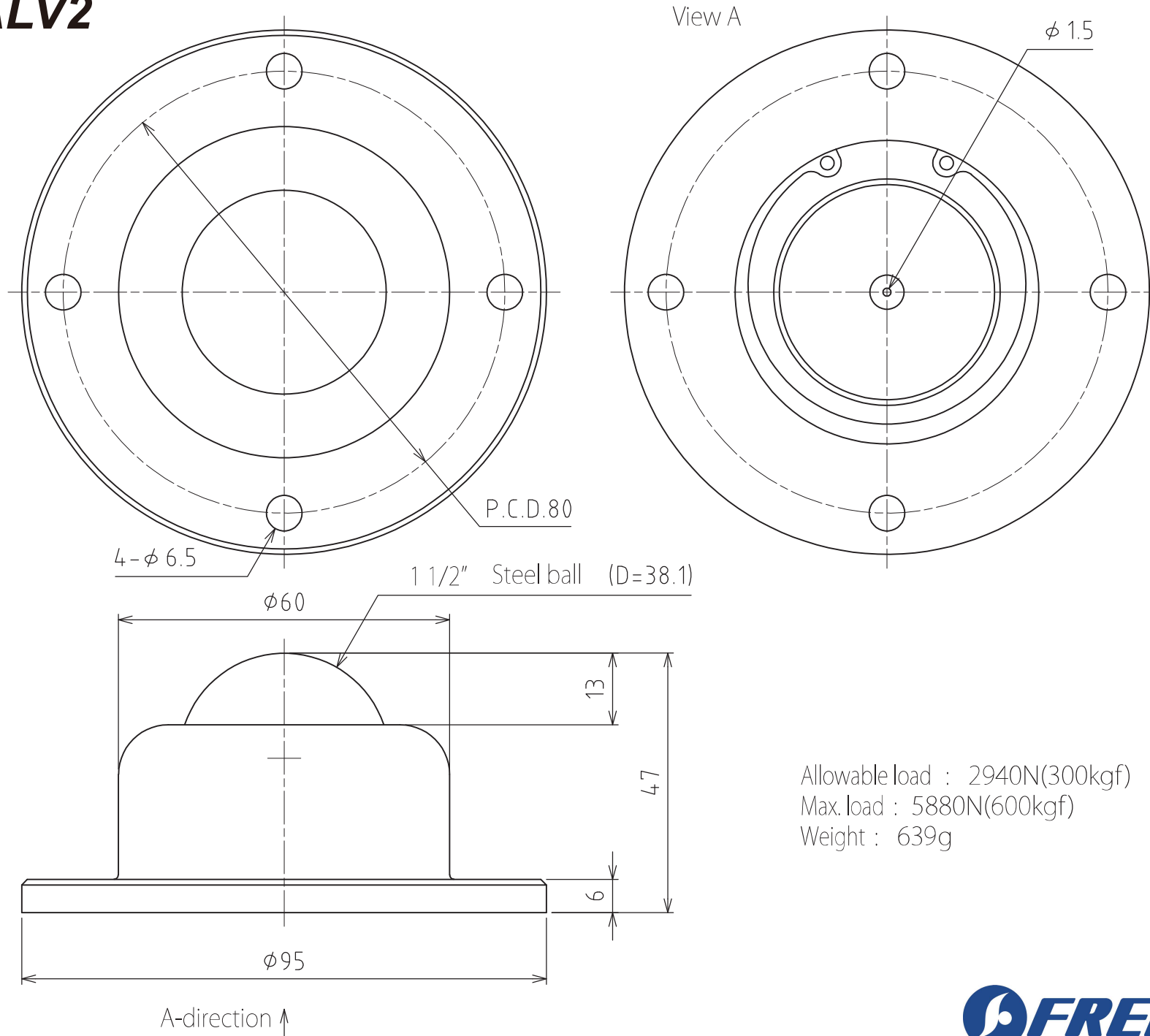

Allowable load : 2940N(300kgf)
Max. load : 5880N(600kgf)
Weight : 639g