

# C-3S

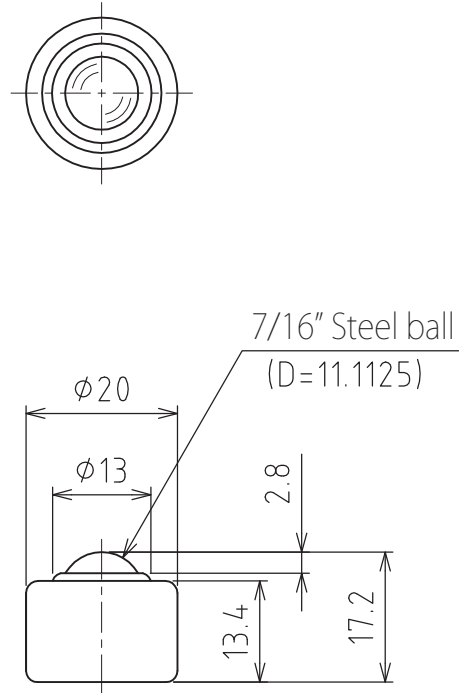

Spring sinking allowance : 1.8mm  
Mounting strength : 49N(5kgf)  
Max. strength : 68N(7kgf)

Allowable load : 49N(5kgf)  
Weight : 18g