

C-8HALV2

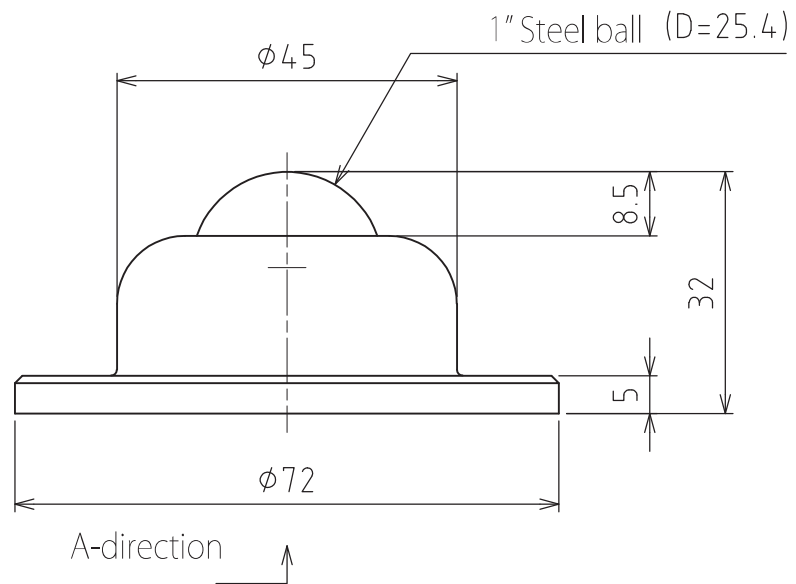
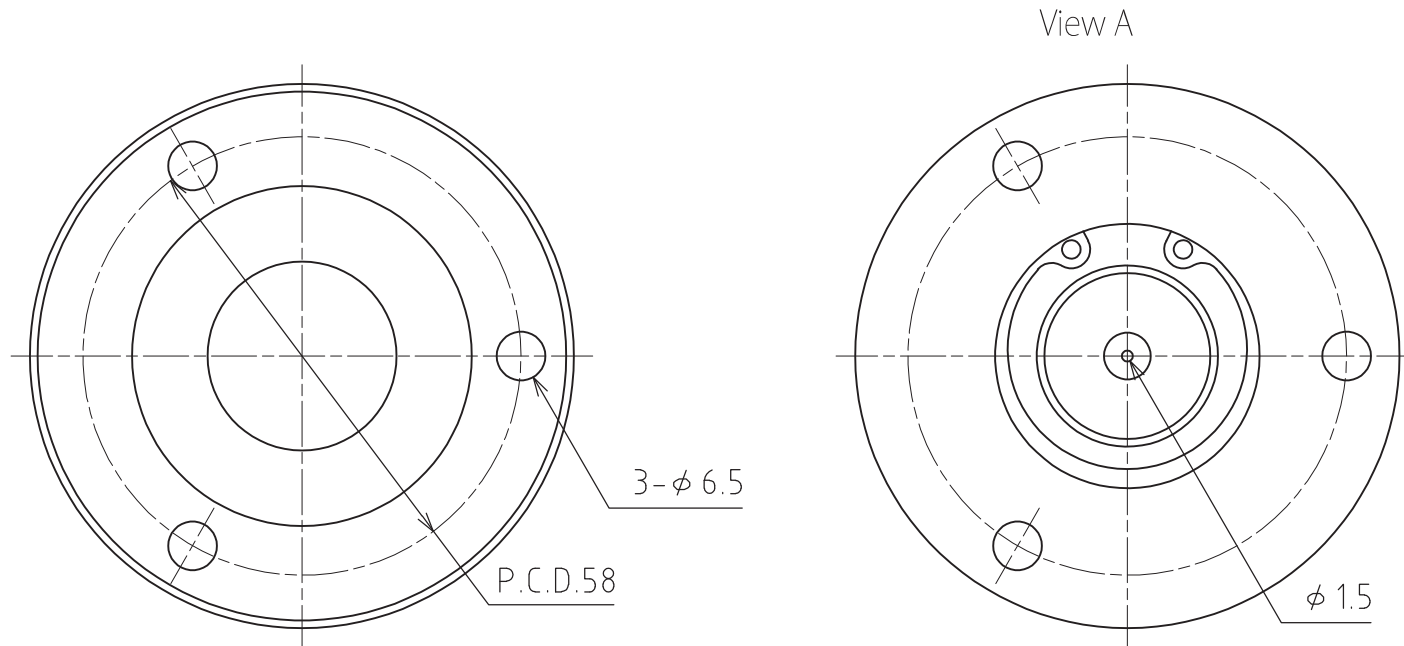

Allowable load : 1176N(120kgf)
Max. load : 2352N(240kgf)
Weight : 209g