

Pneumatically Actuated Freebear Unit
Square groove insertion type AFU-5050-4P Series
Instruction Manual

Thank you for purchasing our product.

Before use, please carefully read the following instructions to ensure proper usage.

We appreciate your cooperation.

1. Summary

This product is a device that assists in the transportation of items through built-in ball bearings (from now on referred to as Freebear), and its operation is controlled by air pressure.

2. Safety Precautions

- Operating air pressure : Use within the range of 0.3MPa to 0.6Mpa.
- Usage environment : For general indoor use.
(0°C to 60°C, avoid freezing and condensation)
※Heat-resistant specifications can be customized upon request.
- Ensure that water or foreign objects do not enter the compressed air system.
- When not in use, release the internal compressed air.
- Avoid severe impact to the product.
- Do not disassemble or modify the product.

3. Installation Method

Add tapped holes at the installation location and secure with the provided CAP bolts.

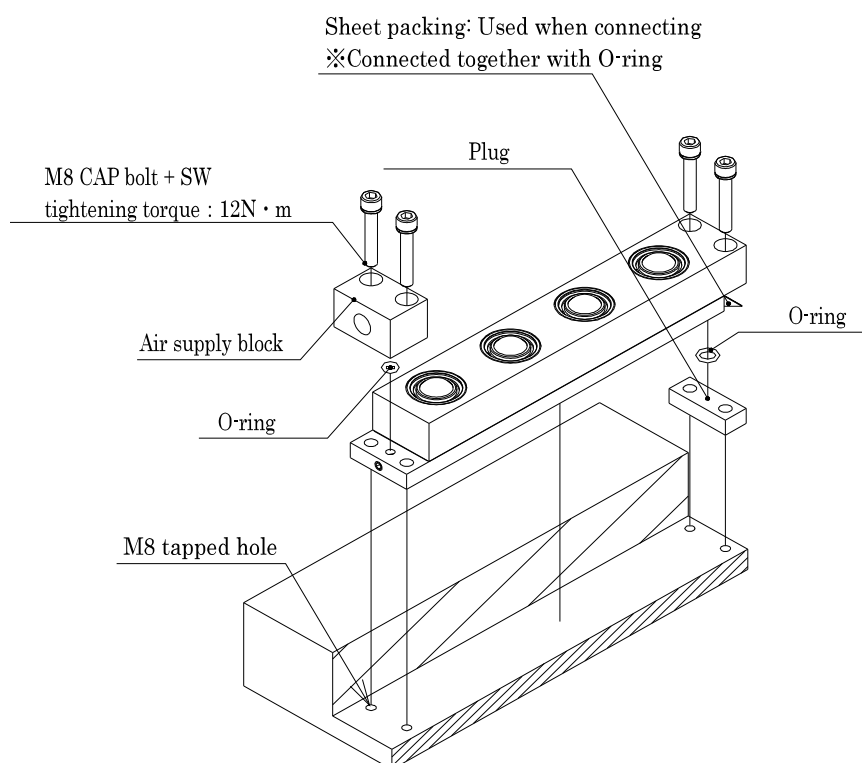

4. Piping Connection

The recommended pneumatic circuit diagram for this product is as follows:

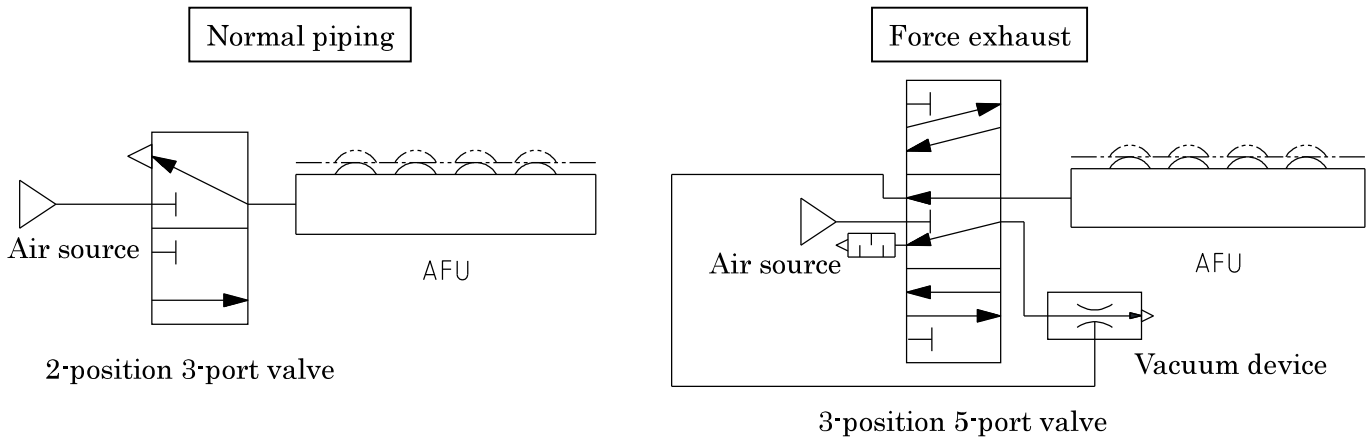

※The Freebear part of this product does not descent naturally when air is exhausted during the downward operation, due to resistance from the cylinder's O-ring, among other factors.(Residual pressure has been released, so it will descent under the load of the transported item's own way, etc.) If it is necessary to force the Freebear part to descent, please refer to the "Forced exhaust" circuit.

5. Connection Method

This product can be connected using the following methods.

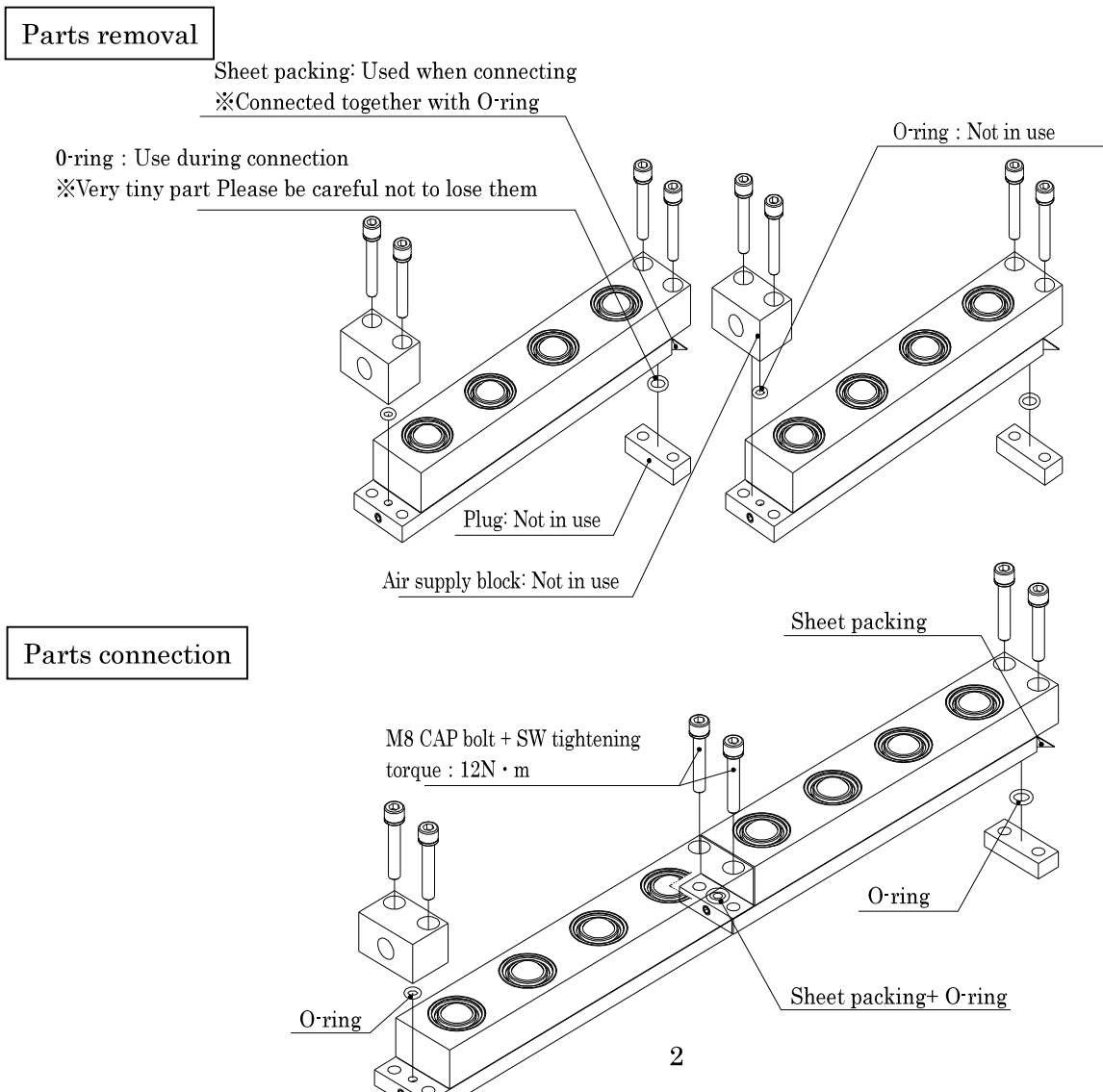

6. Precautions for Use

- ① When placing and moving transported items on this product, ensure that when Freebears rise to the highest point, the top surface remains level with the contact surface of the item.

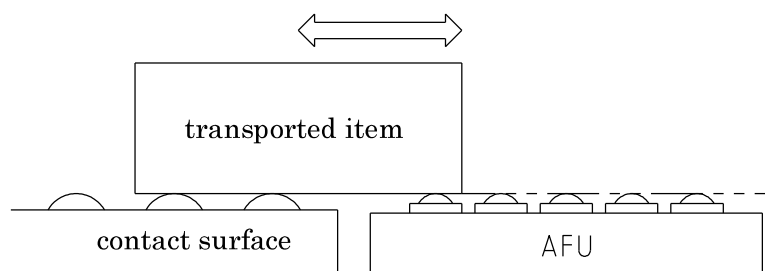

- ② When the transported item cannot be supported by all Freebears, the load capacity and the transportation ability of this product may decrease.

For example,

- a) lightening holes on the bottom
- b) protrusions on the bottom
- c) holes on the bottom, etc.

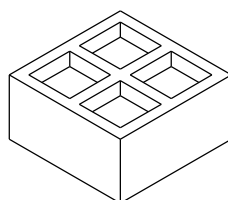

a

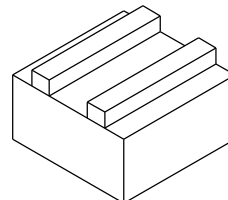

b

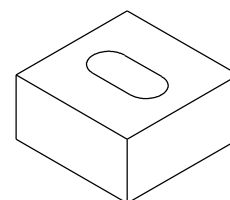

c

- ③ Please set up this product on a flat surface without unevenness.
- ④ Do not clamp the transported item while the Freebears are in the raised position.

7. Maintenance and Inspection

When the Freebear is dirty, clean it with a cloth using low-viscosity lubricating.

8. Inquiry

Should this product operate abnormally or should you have any questions, please contact us or the store/ agent where you purchased it.

※The specification and appearance of this product are subject to change without notice due to the need for improvement.

株式会社フリーベアコーポレーション

Freebear Corporation

発行：2024.08.01_ver.1.0